

# LED

## H 工矿灯规格书

‘H’ High Bay Light Datasheet



|        |
|--------|
| 300W   |
| HB300B |

深圳市勤仕達照明有限公司

King Star Opto-Electronic Co.,LTD.

深圳市寶安區西鄉街道筲竹角村鴻業工業園 4 棟

4<sup>th</sup> Bldg, Hongye Industrial Park, Lezhujiao Village, Xixiang Town, Bao'an District, Shen zhen, China

TEL: (86)755 2908 2005/2006/2016

FAX: (86)755 2908 2009/2015

E-mail: [outdoor@ks-light.com](mailto:outdoor@ks-light.com)

Http://[www.ks-light.com.cn](http://www.ks-light.com.cn)

## Product Appearance Dimensions:

|   |  |
|---|--|
| 300W H LED High Bay Light   | Product Features:  |
|  | <ol style="list-style-type: none"> <li>1. 高功率、高光效 LED 投光灯。<br/>High Power , High luminous efficient LED High Bay Light.</li> <li>2. 防水等级: IP65。<br/>Waterproof IP65.</li> <li>3. 高压铸铝成型外壳, 整灯一体高效散热, 使用寿命可达 50000 小时, 省电 80% 以上。<br/>Die-casting heatsink ,intergrated cooling housing ,lifetime can be up to 50,000 h, energy saving up to 80%.</li> <li>4. 4mm 钢化玻璃, 高强度保护光源, 透光率达到 93%。<br/>4mm tempered glass,safely protect the lighting source, and the transparent rate up to 93%.</li> <li>5. 不锈钢螺丝及配件, 耐空气、水、以及酸、碱、盐等化学溶液腐蚀。<br/>Stainless steel screws and parts.Endurancing the corrosion of air ,water,chemical acid,alkaline,salt and other materials .</li> <li>6. 螺杆锁附式安装, 支架可大角度调节 216°, 照射角度随意变化。<br/>With multiple adjustment points, the adjustment angle can be up to 216°.</li> <li>7. 高纯铝反光罩, 防氧化、变色、放光效果好。<br/>The reflector is made od pure aluminium(99.8%) which anti-oxidation and unfading in colour ,ensureing the reflection.</li> </ol> |

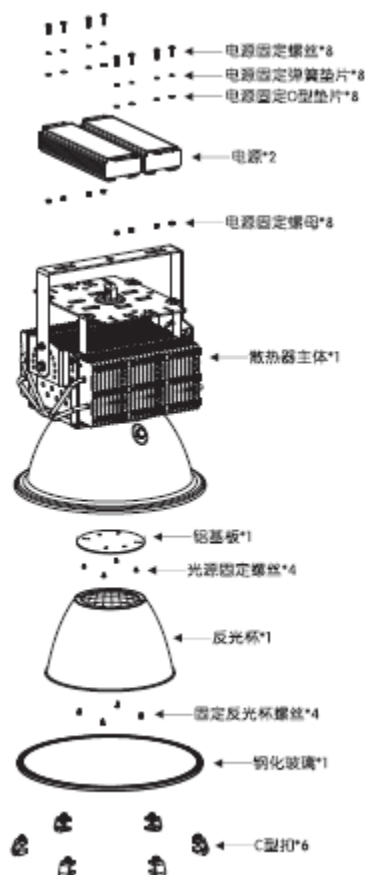

# Product Dimension:

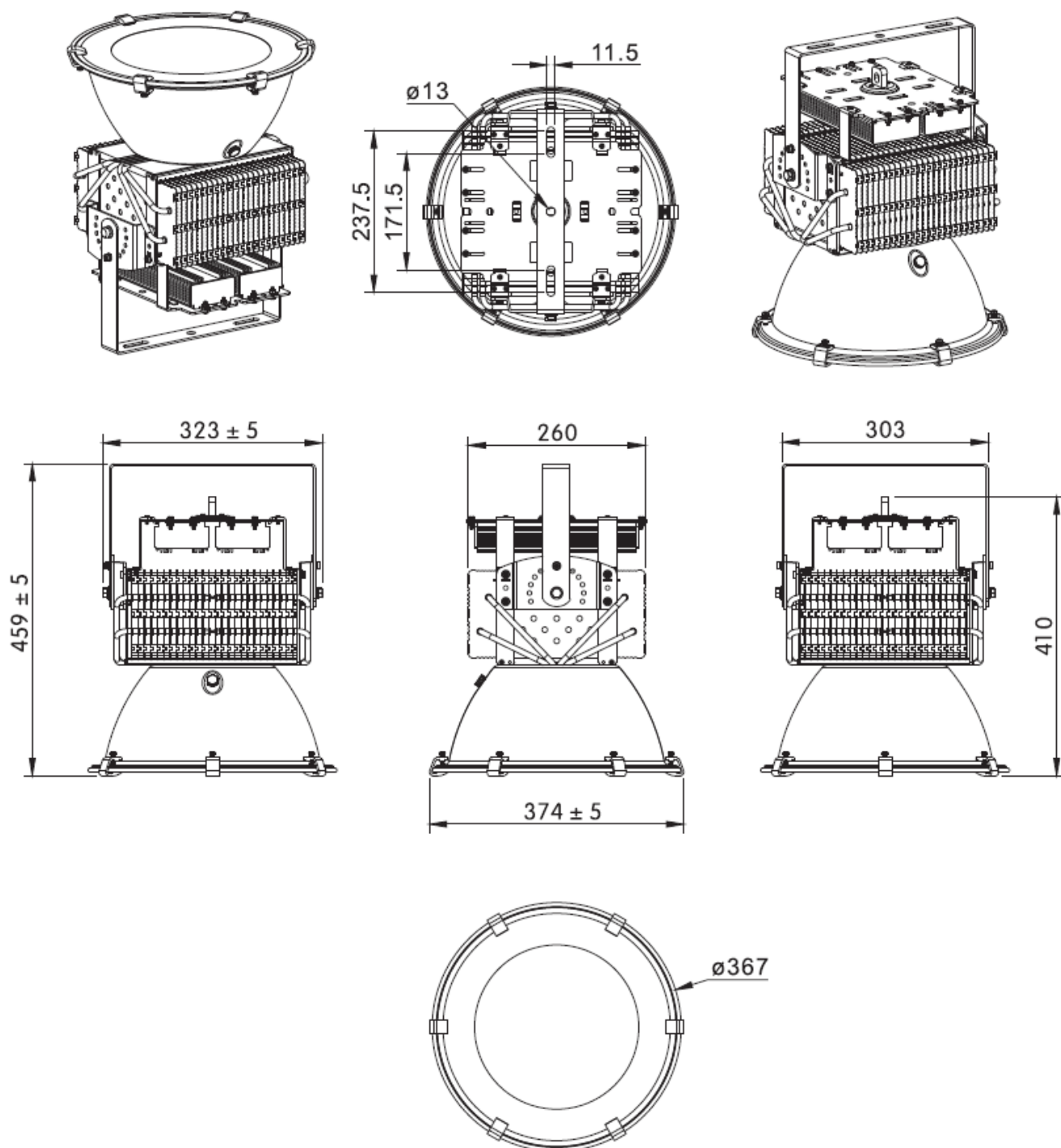

## Product Spec.: HB300B

| 電氣特性 (Electrical Characteristics)   |   | 光學特性(Optical Properties)          |                              |            |
|-------------------------------------|---|-----------------------------------|------------------------------|------------|
| 電源<br>Power Supply                  | With External Power                         | 光源<br>LED Type                    | SMD3535 or CREE XBD          |            |
| 輸入電壓<br>Input Voltage               | AC90-305V / 50-60Hz                         | 光源數量<br>LED Q'ty                  | 192 pcs or 192pcs            |            |
| 額定功率<br>Rated Power                 | 300W  | 流明值<br>Lumen                      | 85--100 lm/W                 |            |
| 功率因素<br>Power Factor                | 0.95-0.98                                   | 顯色指數<br>CRI                       | ≧ 70 Ra or ≧ 80 Ra           |            |
| 防護等級<br>Waterproof                  | IP65  | 發光角度<br>Beam Angle                | 25° / 45° / 60° / 90° / 100° |            |
| 使用壽命<br>Life Time                   | ≧ 50000H                                    | 色溫<br>CCT                         | warm white                   | 2800-3200K |
|                                     |   |                                   | Natural white                | 3750-4250K |
|                                     |   |                                   | Pure white                   | 4750-5250K |
|                                     | 5700-6500K                                  |                                   |                              |            |
| 產品材質 (Product Material)             |   |                                   |                              |            |
| 外殼材質<br>Body material               | 電源線<br>Power Wire                           | 電氣安全等級<br>Electronic safety grade |                              |            |
| AL Spinning member,<br>Silver paint | 3*1.0mm <sup>2</sup><br>Rubber cable L=0.5M | I class                           |                              |            |
| 产品与包装规格尺寸(Standard Dimensions)      |   |                                   |                              |            |
| 產品尺寸<br>Product Dimension           |   | 毛重<br>G.W.                        |                              |            |
| 410 mm(H)* Ø 374.5 mm               |   | kg                                |                              |            |

## Package:

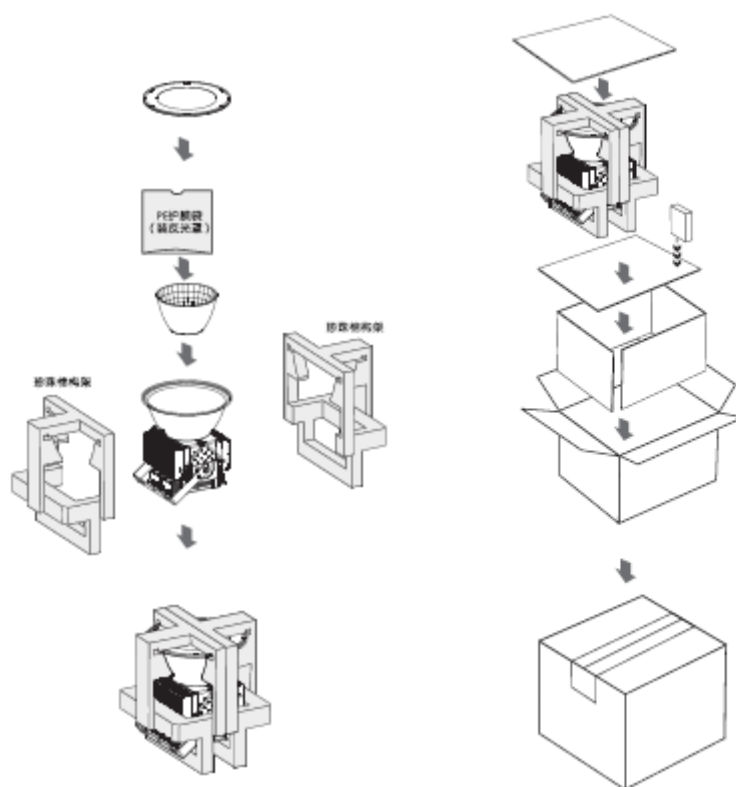

1. 主体包材：（Packaging material）：  
大纸箱 Packing Box： 47.5cmx47.5cmx51cm
2. 数量（QTY）： 1 PCS/CTN
3. 毛重（G.W.）： KG

## 创新精点 Product Features

- 大功率 LED 灯的散热问题得到完美解决，可替代 600W 至 1000W 的大功率传统钠灯，并节能一半，填补了大功率灯具的市场空白。

The heat problem of High power LED light have been perfectly solved. And can be replace traditional 600W to 1000W high power sodium lamps, and can energy-saving half.

- “HDT、扣 FIN、插齿、压管”四大穿心专利生产工艺，让大功率 LED 灯具重量更轻、装配更简单、结构更坚固，散热性能更好。

‘HDT, FIN buckle, slotting , pressuer pipe’, the patented production process , make the Hight-power LED highbay light are lighter, and easier to assemble, and the stucture is more robuster and better themal perfomance.

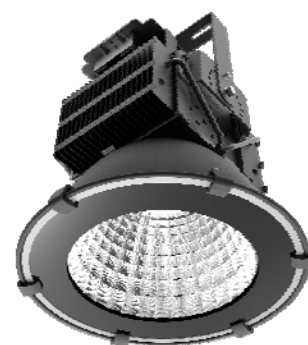

- 模组式拼装设计，支持功率多样化，丰富产品品种。

Modular assembly designed to support power diversification and variety.

## 设计亮点



### 216° 可调角度

### 216° adjustable angle

13 个支架调节点，角度可调节 216°，照射角度随意变化。

13 flexible positions makes project angle can be adjusted within 216° .

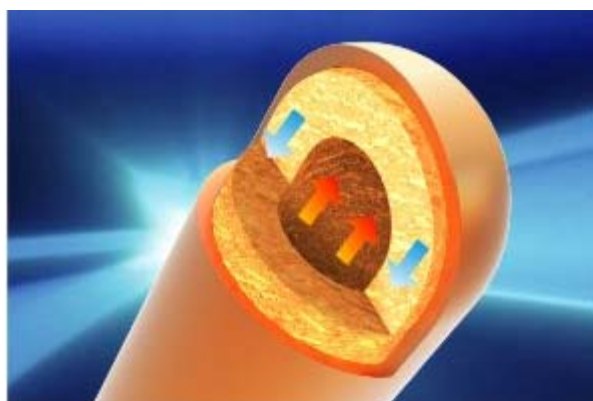

### 纯铜热管

### Copper heatpipe

采用热管铆接鳍片散热技术，热管将光源散发的热量迅速地传到到鳍片上，热度迅速三区，以达到快速降低灯具温度的效果，延长灯具使用寿命。

By riveting the heatpipe to the fins, the heatpipe can conduct heat rapidly from chips bottom to the fins, greatly lower down the temperatire of

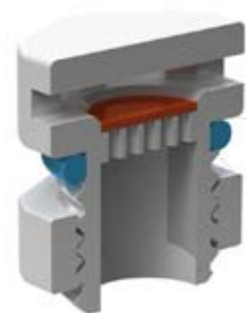

### 灯罩呼吸器设计

### Respirator design

防水的同时又清除雾气，避免凝露，提升产品品质，延长使用使用寿命

Waterproof design ,eliminating mist ,avoiding condensation, improving quality , extending the life span.



### 高反光率

### High reflective rate

反光杯反光角度：25° / 45° / 60° / 90° / 100°

Reflector's beam angle: 25° / 45° / 60° / 90° / 100°

light ,extending the life span.



## 05 适用场所 Applications

工厂、仓库、体育馆、亮化工程、广场、高尔夫球场、船舶、机场、地铁、商业场所、户外广告、地标建筑等外墙面全景照明。

Led High Bay light is widely used in factory, warehouse, stadium, engineering, square, golf courses, ships, airports, subway, commercial facilities, outdoor advertising, landmarks ect.

## 06 套件展示

### Kit Show



#### 高效散热 Efficient heat dissipation



采用模组化散热体与热管铆接技术，  
3D 立体快速散热。

Adopting modularization riveting technology and copper pipe heat dissipation body,  
3D rapid cooling.

#### 简易装配 Easy Installation



装配简单方便日常维护。

Simple assembly enables easy routine maintenance.

#### 纯铜热管 Copper heatpipe



快速降温，延长光源寿命。  
Rapid cooling, extend the life of the light source.

## 专业设计 Professional Design



时尚质感，专业散热器设计，  
受多项专利技术保护。

Fashionable radiator design,  
Protected by a number of patented technology.



## 防水等级 IP65 Waterproof IP65

防灰尘，雨水侵入  
Dustproof , waterproof



## 反光率 92% 92% reflective rate

极大提高亮度，节能又增光  
Greatly improve the brightness, energy saving.