

LED

H 工矿灯规格书

‘H’ High Bay Light Datasheet



150W
HB150B

深圳市勤仕達照明有限公司

King Star Opto-Electronic Co.,LTD.

深圳市寶安區西鄉街道筲竹角村鴻業工業園 4 棟

4th Bldg, Hongye Industrial Park, Lezhujiao Village, Xixiang Town, Bao'an District, Shen zhen, China

TEL: (86)755 2908 2005/2006/2016

FAX: (86)755 2908 2009/2015

E-mail: outdoor@ks-light.com

Http://www.ks-light.com.cn

Product Appearance Dimensions:

150W H LED High Bay Light	Product Features:
	<ol style="list-style-type: none"> 1. 高功率、高光效 LED 投光灯。 High Power , High luminous efficient LED High Bay Light. 2. 防水等级: IP65。 Waterproof IP65. 3. 高压铸铝成型外壳, 整灯一体高效散热, 使用寿命可达 50000 小时, 省电 80% 以上。 Die-casting heatsink ,intergrated cooling housing ,lifetime can be up to 50,000 h, energy saving up to 80%. 4. 4mm 钢化玻璃, 高强度保护光源, 透光率达到 93%。 4mm tempered glass,safely protect the lighting source, and the transparent rate up to 93%. 5. 不锈钢螺丝及配件, 耐空气、水、以及酸、碱、盐等化学溶液腐蚀。 Stainless steel screws and parts.Endurancing the corrosion of air ,water,chemical acid,alkaline,salt and other materials . 6. 螺杆锁附式安装, 支架可大角度调节 216°, 照射角度随意变化。 With multiple adjustment points, the adjustment angle can be up to 216°. 7. 高纯铝反光罩, 防氧化、变色、放光效果好。 The reflector is made od pure aluminium(99.8%) which anti-oxidation and unfading in colour ,ensureing the reflection.

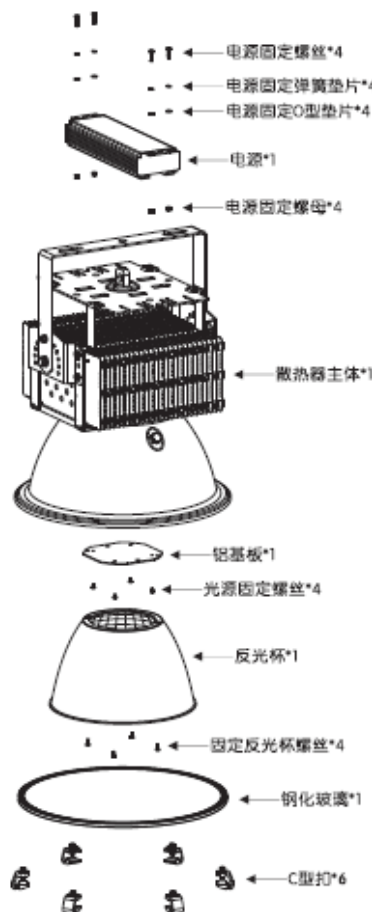

Product Dimension:

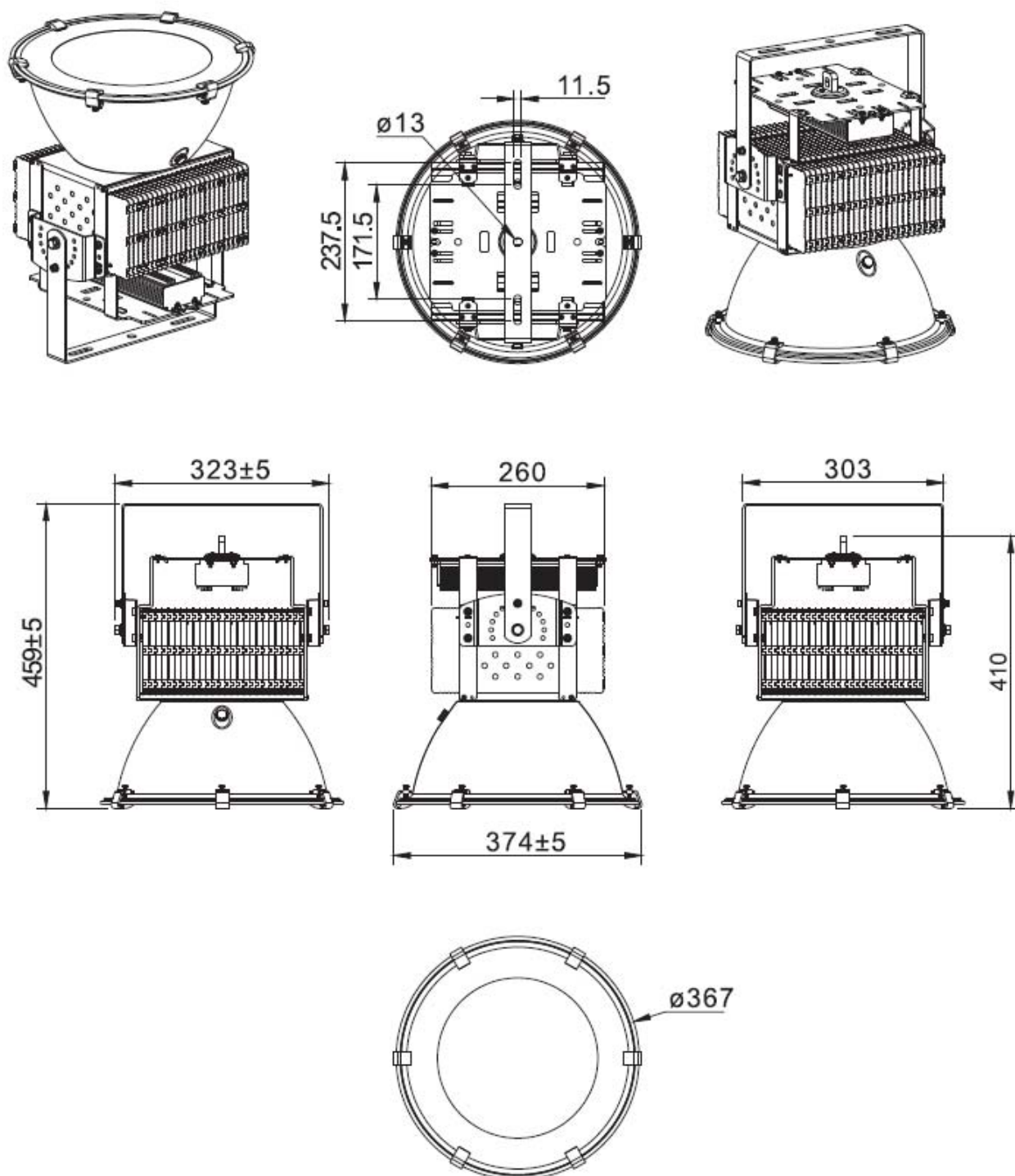

Product Spec.: HB150B

電氣特性 (Electrical Characteristics)		光學特性(Optical Properties)		
電源 Power Supply	With External Power	光源 LED Type	SMD2835	
輸入電壓 Input Voltage	AC90-305V / 50-60Hz	光源數量 LED Q'ty	300 pcs*0.5W	
額定功率 Rated Power	150W	流明值 Lumen	90--100 lm/W	
功率因素 Power Factor	0.95-0.98	顯色指數 CRI	≧ 70 Ra or ≧ 80 Ra	
防護等級 Waterproof	IP65	發光角度 Beam Angle	25° / 45° / 60° / 90° / 100°	
使用壽命 Life Time	≧ 50000H	色溫 CCT	warm white	2800-3200K
			Natural white	3750-4250K
			Pure white	4750-5250K
	5700-6500K			
產品材質 (Product Material)				
外殼材質 Body material	電源線 Power Wire	電氣安全等級 Electronic safety grade		
AL Spinning member, Silver paint	3*1.0mm ² Rubber cable L=0.5M	I class		
產品與包裝規格尺寸(Standard Dimensions)				
產品尺寸 Product Dimension		毛重 G.W.		
410 mm(H)* Ø 374.5 mm		kg		

Package:

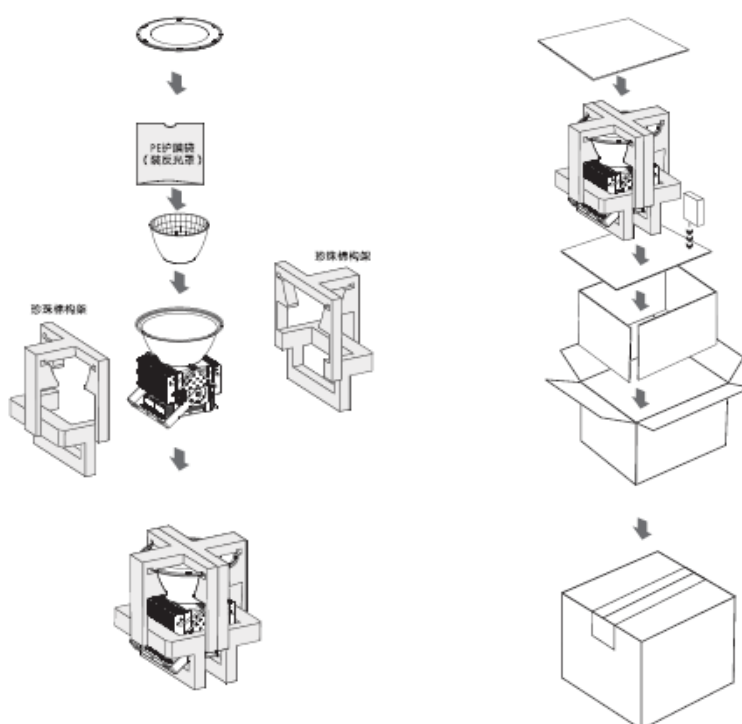

1. 主体包材：（Packaging material）：
大纸箱 Packing Box: 48cmx48cmx51.5cm
2. 数量（QTY）： 1 PCS/CTN
3. 毛重（G.W.）： KG

创新精点 Product Features

- 大功率 LED 灯的散热问题得到完美解决，可替代 600W 至 1000W 的大功率传统钠灯，并节能一半，填补了大功率灯具的市场空白。

The heat problem of High power LED light have been perfectly solved. And can be replace traditional 600W to 1000W high power sodium lamps, and can energy-saving half.

- “HDT、扣 FIN、插齿、压管”四大穿心专利生产工艺，让大功率 LED 灯具重量更轻、装配更简单、结构更坚固，散热性能更好。

‘HDT, FIN buckle, slotting , pressuer pipe’, the patented production process , make the Hight-power LED highbay light are lighter, and easier to assemble, and the stucture is more robuster and better themal perfomance.

- 模组式拼装设计，支持功率多样化，丰富产品品种。

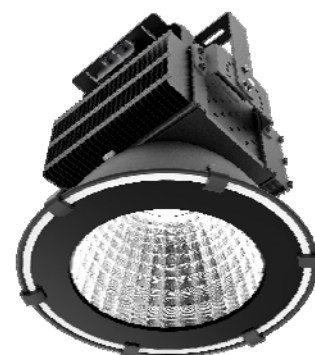

Modular assembly designed to support power diversification and variety.

设计亮点



216° 可调角度

216° adjustable angle

13 个支架调节点，角度可调节 216°，照射角度随意变化。

13 flexible positions makes project angle can be adjusted within 216° .

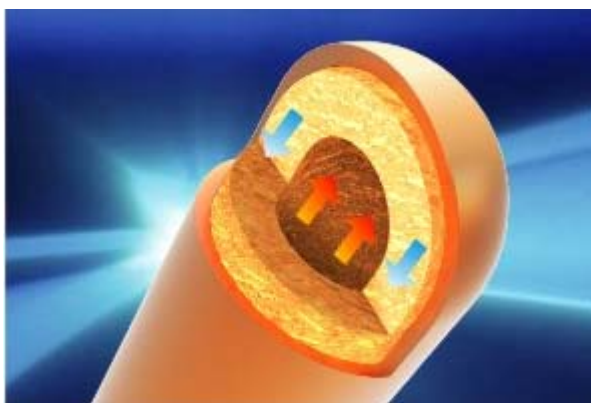

纯铜热管

Copper heatpipe

采用热管铆接鳍片散热技术，热管将光源散发的热量迅速地传到到鳍片上，热度迅速三区，以达到快速降低灯具温度的效果，延长灯具使用寿命。

By riveting the heatpipe to the fins, the heatpipe can conduct heat rapidly from chips bottom to the fins, greatly lower down the temperatire of light ,extending the life span.

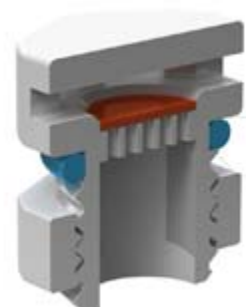

灯罩呼吸器设计

Respirator design

防水的同时又清除雾气，避免凝露，提升产品品质，延长使用使用寿命

Waterproof design ,eliminating mist ,avoiding condensation, improving quality , extending the life span.

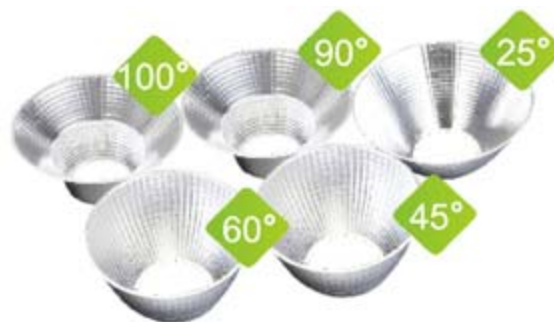

高反光率

High reflective rate

反光杯反光角度：25° / 45° / 60° / 90° / 100°

Reflector's beam angle: 25° / 45° / 60° / 90° / 100°

05 适用场所 Applications

工厂、仓库、体育馆、亮化工程、广场、高尔夫球场、船舶、机场、地铁、商业场所、户外广告、地标建筑等外墙面全景照明。

Led High Bay light is widely used in factory, warehouse, stadium, engineering, square, golf courses, ships, airports, subway, commercial facilities, outdoor advertising, landmarks ect.

06 套件展示

Kit Show



高效散热 Efficient heat dissipation



采用模组化散热体与热管铆接技术，
3D 立体快速散热。

Adopting modularization riveting technology and copper pipe heat dissipation body,
3D rapid cooling.

简易装配 Easy Installation



装配简单方便日常维护。

Simple assembly enables easy routine maintenance.

纯铜热管 Copper heatpipe

快速降温，延长光源寿命。
Rapid cooling, extend the life of the light source.

专业设计 Professional Design



时尚质感，专业散热器设计，
受多项专利技术保护。

Fashionable radiator design,
Protected by a number of patented technology.



防水等级 IP65 Waterproof IP65

防灰尘，雨水侵入
Dustproof , waterproof



反光率 92% 92% reflective rate

极大提高亮度，节能又增光
Greatly improve the brightness, energy saving.